

NNWI

# HOME AND PERSONAL SECURITY HANDBOOK



© 2001, 2006 NNWI



## ON THE INSIDE

A Guide to Home and Personal Security ..... 2

Avoiding Trouble ..... 3

An 88 Question Home and Personal Security Survey ..... 5

Locks ..... 9

Doors ..... 12

Windows ..... 15

ATM Precautions ..... 17

Minimize Car-Jacking Risks ... 18

Apartment Security ..... 19

Vacation Preparations ..... 20

Holiday Season ..... 22

Home Alone ..... 23

Battered Women ..... 24

Sexual Assault ..... 25

Rural Security ..... 27

Operation ID ..... 28

NNWI Catalog ..... 30

20 Questions ..... 32

A PUBLICATION OF THE

National  
**Neighborhood Watch**  
Institute

P.O. Box 4208, Santa Fe Springs, CA 90670-1208

**VOICE**  
888-NNWI-USA  
**888-669-4872**

**FAX**  
888-FAX-NNWI  
**888-329-6694**

**WEB**  
[www.nnwi.org](http://www.nnwi.org)

# A GUIDE TO HOME AND PERSONAL SECURITY

**I**n this manual the **National Neighborhood Watch Institute** offers you hundreds of ideas to protect your home, yourself and your family. Your home can not be absolutely protected against burglars. You, yourself, can not be absolutely safe as you go about your daily activities at home, in your neighborhood, while driving, shopping, banking or working. So **what can you do** about your home and personal security? As

the Boy Scout motto admonishes us: **Be prepared!**

A professional burglar can outwit any lock, alarm system, window or door on the market. But in 99 out of 100 burglaries, it is not a professional thief but more typically a young teenager living in the neighborhood or a drug addict committing the crime. He is probably looking for something to fence.

You can cut down on your chances of being burglarized by applying the

## *Three D's of Protection:*

**Deterrence** - Good lighting, an alert Neighborhood Watch program, sturdy doors, windows and locks make it hard for a burglar to break in. A very extensive checklist begins on page 4. You are asked 88 questions about general neighborhood security, the doors and windows

of your home, personal security and your fire prevention habits. Any hesitation in answering "Yes" to a question brings out an area where a lack of security exists.

**Delay** - Good home security will slow a burglar down. They will not waste time or expose their intentions for long if they can not find an easy target. A few minutes

delay, an alert neighbor, and they will be caught. They usually know that and will go elsewhere. We offer a detailed look, with 50 illustrations of locks, doors and windows on pages 9 to 16.

**Detection** - An alarm system covering the perimeter (doors and windows) and interior (motion detectors) of your home, a barking dog and a good Neighborhood Watch program are your best protectors.

Personal safety is also an important consideration of this manual. On the next page you will find a good deal of common sense ideas on precautions enabling you to avoid trouble when you are out on the street, in your car, if you use a bus and if you are in your office.

Know in advance exactly how to respond to a car-jacker or an ATM robber. Faced with one of these dangerous situations, be ready to face your attacker armed with some preparatory training. Offered here are common sense guides and tips you should know for your own protection. Read about these on pages 18 and 17. Share them with your family.

Apartment security (page 19), Holiday Season Suggestions (pages 22-23), Kids Being Home Alone (page 23), Vacation Preparations (pages 20-21), Battered Women (pages 24-25), Sexual Assault (pages 25-26), Rural Security (page 27) are additional subjects. Operation Identification, a system to protect your personal property is explained on pages 28 and 29.

All in all, you will find the few dollars you spent on this manual an excellent investment.



# AVOIDING TROUBLE

**T**he best crime prevention is observing crime avoidance. Don't put yourself and your family in a situation where crime will most often occur. **Be prepared.** By taking a few simple precautions, you can reduce the risk to yourself and your family by discouraging those who commit crime. **Talk through these ideas with your family.** Teach them to always be alert and aware of the people around them. Teach them to be especially alert at locations and in situations which can make you all vulnerable to crime, such as

alleys, dark parking lots and ATM machines. While you are teaching them, you reinforce in your own mind the crime prevention tactics we offer here.

## *Street precautions:*

- 1** Be alert to your surroundings and the people around you, especially if you are alone or it is dark.
- 2** Whenever possible, travel with a friend.
- 3** Stay in well-lighted areas as much as possible. Carry a small flash light if out at night.
- 4** Walk close to the curb. Avoid doorways, bushes and alleys where someone could hide.
- 5** Walk confidently, and at a steady pace.

- 6** Make eye contact with people when walking.
- 7** Do not respond to conversation from strangers on the street, continue walking.
- 8** If you carry a purse, hold it securely between your arm and your body.

## *Car Safety:*

- 1** Always lock car doors after entering or when leaving your car.
- 2** Park in well-lit, active, areas.
- 3** Have your car keys in your hand so you don't have to linger before entering your car.
- 4** Check the back seat before entering your car.
- 5** If you think you are being followed, drive to a public place or a police, sheriff or fire station.

© Copyright 1996, 2006 by National Neighborhood Watch Institute



- 6** If your car breaks down, open the hood and attach a white cloth to the car antenna.
- 7** If someone stops to help, stay in the locked car, roll down the window just a little and ask them to call the police, sheriff, AAA or a tow truck.
- 8** Don't stop to aid motorists stopped on the side of the road. Go to a phone and request help for them.

### *Waiting for a Bus:*

- 1** Avoid isolated bus stops.
- 2** Keep safely away from the curb until the bus arrives.
- 3** Don't open your purse or wallet while boarding the bus. Have your pass or money ready in your hand or in an easily accessible pocket. Before you board the bus, keep your purse at your side with your hand clutching it.

- 4** Don't invite trouble — keep gold chains out of sight; don't flash your jewelry and turn your rings around so the stones don't show.

### *On the bus:*

- 1** During off-hours, sit as close to the bus driver as possible.
- 2** Stay alert — and be aware of the people around you.
- 3** If someone bothers you, change seats and/or tell the driver.

- 4** Carry your wallet inside your coat, or in a front pocket. A comb, placed horizontally in the fold of your wallet, will alert you if someone tries to remove it from your pocket.

- 5** Keep your handbag in front of you and hold it close to your body with both hands.,

- 6** Check your purse or wallet if someone is jostling, crowing or pushing you.

- 7** If you see any suspicious activity, immediately tell the driver.



© Copyright 1996, 2006 by National Neighborhood Watch Institute

### *Office security:*

- 1** Never leave your purse or billfold in plain view or in the pocket of a jacket hanging on a door.

- 2** Personal property should be marked with your driver's license number (preceded with the state initials such as CA)

- 3** Don't leave cash or valuables at the office.

- 4** If you work alone or before/after normal business hours, keep the office door locked.

- 5** If you work late, try to find another worker or a security guard to walk out with you.

- 6** If you are in the elevator with another person, stand near the control panel. If you are attacked, press the alarm and as many of the control buttons as possible.

- 7** Be alert for pickpockets on crowded elevators.

- 8** Report all suspicious people and activities to the proper authorities as soon as possible to the office manager, building security or law enforcement.

# AN 88 QUESTION HOME AND PERSONAL SECURITY SURVEY

When you play a piano, you need to have all 88 keys tuned correctly to play a melody well. With home and personal security, you need to answer all 88 questions with a "Yes" to assure yourself you are tuned in to the maximum security you can personally provide. **If you answer "No" on any question, pay attention to what you could do to improve your, and your family's, safety and security.**

## Neighborhood Security

	Yes	No
<b>1</b> Is your house number visible from the street, with numbers at least 3" high?	___	___
<b>2</b> Can your neighbors see your house?	___	___
<b>3</b> Do you know your neighbors, including all occupants of their houses?	___	___
<b>4</b> Have you talked to your neighbors about mutual neighborhood security?	___	___
<b>5</b> Do you leave your front and back porch light on every night whether you are home or not?	___	___
<b>6</b> Do you routinely lock your door every time you leave - no matter how short a time?	___	___
<b>7</b> Do you never leave keys for a maid or repairman to come in?	___	___

## Doors and Windows

<b>8</b> Are your outside entrance doors all solid core doors, strong enough to withstand excessive force?	___	___
<b>9</b> Do your door frames fit snugly around your exterior doors?	___	___
<b>10</b> Are the strike plates and frames strong enough to withstand excessive force?	___	___
<b>11</b> Do you have a wide angle viewer installed in your front and back doors?	___	___
<b>12</b> If you have a small child at home, have you installed a wide-angle viewer they can see through?	___	___
<b>13</b> Are all your outside doors equipped with single-cylinder one-inch deadbolt locks?	___	___
<b>14</b> Do you have a double cylinder lock for doors with glass or panels?	___	___
<b>15</b> Can you close and LOCK your garage door? Is it easily opened with a remote?	___	___
<b>16</b> Do you close and LOCK your garage door? <b><u>Not just "can you?"</u></b>	___	___
<b>17</b> Do you do the same for the pedestrian doors going into the garage from your house or yard?	___	___
<b>18</b> Do your basement doors have extra protection?	___	___
<b>19</b> Do your basement windows have metal screens or other protection?	___	___
<b>20</b> Do your casement windows work properly, without excess play?	___	___

- 21 Do you check to see if all windows are locked whenever you leave the house?
- 22 Do you put a board or dowel that snugly fits in the track of your sliding glass door?
- 23 Have you pinned your sliding glass door?
- 24 Have you done the same for your sliding windows?
- 25 Do all your windows have good locks on them?
- 26 If you have any louvered windows, are the panels epoxied (glued) into place?
- 27 Have you ever walked around your house looking for ways a burglar might be able to get in?
- 28 Have you trimmed all your hedges, bushes and trees so they can't hide a burglar at work on your windows and doors?
- 29 If you live in an apartment or other multi-unit dwelling, do you make it a point to immediately notify management of any lighting or other security problems?
- 30 Do you have Neighborhood Watch Warning Decals on your windows?

## Personal Security

- 31 Do you know the **emergency** phone number of your local law enforcement agency?
- 32 Do you know the **business** phone number of your local law enforcement agency?
- 33 Do you know your nearest fire department and rescue service phone numbers?
- 34 Do you ask neighbors to watch your house if you are going to be gone over night?
- 35 Do you have automatic timers on a couple of lights, TV and radios in your house when you are away?
- 36 Does your house always look like someone is at home?
- 37 Do you stop newspapers, mail and other deliveries when you are going to be gone for extended periods?
- 38 Do you ask your neighbors to mow your lawn, rake your leaves or remove snow when you are gone for an extended period?
- 39 Do you notify your local law enforcement agency, or your Neighborhood Watch Block Captain, when you're going out of town so they can check your house for you?
- 40 Have you recorded the make, model and serial numbers of all your valuables?
- 41 Have you etched your driver's license number on valuables?
- 42 Have you photographed items you can't etch or have no serial numbers such as jewelry, china, and crystal for identification purposes?
- 43 Have you recorded all your credit card and ATM numbers, together with the phone numbers to cancel them should they get lost or stolen?

- 44 Do you shield your keypad entry when you enter your Personal Identification Number into an ATM machine? \_\_\_ \_\_\_
- 45 Have you removed all identification tags from your key ring? \_\_\_ \_\_\_
- 46 Do you always lock your car when you get out? \_\_\_ \_\_\_
- 47 Do you have a working flashlight when traveling at night? \_\_\_ \_\_\_
- 48 Do you look in your car, especially the back seat of your car, before you get in? \_\_\_ \_\_\_
- 49 Do you put all packages in the trunk instead of the back seat? \_\_\_ \_\_\_
- 50 If you have small children, have you taught them how to identify a store clerk to whom they could ask for help should they become separated from you? \_\_\_ \_\_\_
- 51 Since you moved in have you had all your door locks rekeyed by a locksmith? \_\_\_ \_\_\_
- 52 Do you turn your bell tone volume down, or off, on your telephone when you are away? \_\_\_ \_\_\_
- 53 Do you have your neighbor park his extra car in your driveway when you are away for a few days? \_\_\_ \_\_\_
- 54 When going on vacation, do you really follow the 33 steps suggested in the Vacation Preparation section of this handbook? \_\_\_ \_\_\_
- 55 Do you report strangers in your neighborhood to your local law enforcement agency? \_\_\_ \_\_\_
- 56 Do you report all suspicious incidents to your local law enforcement agency? \_\_\_ \_\_\_
- 57 Does your neighborhood have a reputation for being a good, safe place, to live? \_\_\_ \_\_\_
- 58 Do you always separate your home and car keys when you leave your car in an attended parking lot? \_\_\_ \_\_\_
- 59 Do you always walk in the traffic lanes in a parking lot rather than next to the parked cars? \_\_\_ \_\_\_
- 60 Do you always approach your car with your keys in your hand, not in your purse? \_\_\_ \_\_\_
- 61 Do you know what you should do if you become a victim of a sexual assault? \_\_\_ \_\_\_
- 62 Do you routinely file off the serial numbers on padlocks you install? \_\_\_ \_\_\_

## Fire Protection Procedures

- 63 Do you and your family know to never use gasoline to start a fire or for cleaning purposes? \_\_\_ \_\_\_
- 64 Do you always store flammable liquids in closed metal containers away from heat, sparks and small children? \_\_\_ \_\_\_
- 65 Are you conscientious about keeping combustibles like newspapers, old clothes, wood furniture and other junk cleared from closets, the garage, basement, attic and yard? \_\_\_ \_\_\_
- 66 Are smoke detectors installed near or on the ceiling, next to each sleeping area in the house as well as other suggested areas and are they in good working order? \_\_\_ \_\_\_

	Yes	No
<b>67</b> Are your smoke detectors the most sensitive you can buy?	___	___
<b>68</b> Do you test each of your smoke detectors monthly and replace their batteries annually?	___	___
<b>69</b> Does every resident of your house practice home fire drills at least annually?	___	___
<b>70</b> Do all family members know how to “stop, drop and roll” to put out a fire?	___	___
<b>71</b> Do all family members know to “shout ‘fire’ and get out” if they wake up in a house on fire?	___	___
<b>72</b> Are all matches and lighters kept safely away from small children?	___	___
<b>73</b> Is the “No Smoking” rule practiced in your house? If not, do you provide ashtrays for smokers?	___	___
<b>74</b> Does everyone fully understand that smoking is NEVER ALLOWED in bed or near over-stuffed furniture and pillows?	___	___
<b>75</b> Does all smoking residue and fireplace ashes get placed in closed metal containers and disposed of safely outside, away from the house and any other combustible materials?	___	___
<b>76</b> Do all fireplaces have metal screens?	___	___
<b>77</b> Are chimneys inspected and cleaned at least annually? Are spark arrestors checked?	___	___
<b>78</b> Do you have at least one fire extinguisher in your residence and garage?	___	___
<b>79</b> Are you careful not to wear loose fitting clothes when starting a fire?	___	___
<b>80</b> Do you immediately discard damaged, worn or frayed electrical cords?	___	___
<b>81</b> Do you take out of service any malfunctioning electric appliance until it is fixed?	___	___
<b>82</b> Do you clean and lubricate, at least two times a year, motors on refrigerators, dryers and other electric appliances?	___	___
<b>83</b> Do you inspect your heating system, including cleaning it, at least once a year?	___	___
<b>84</b> Do you and your family respect the danger of fire by keeping clothes, drapes and miscellaneous storage at least 12” away from baseboard and portable heaters and 36” away from furnaces?	___	___
<b>85</b> Do you routinely keep pan handles turned in from the cook top edge and cords out of the way?	___	___
<b>86</b> Do you know which kind of fires require which kind of treatments? (As an example, knowing not to put out a grease or electrical fire with water.)	___	___
<b>87</b> Do you routinely keep a pan lid handy when cooking for smothering flames in case of a grease fire in the frying pan?	___	___
<b>88</b> Do you conscientiously check to make sure electric cords and appliances, including tools and accessories used around your car, are not used where water is standing?	___	___

Yes, it is quite a list. Quite time-consuming you might say. But just consider this: **What are the consequences to you or a loved one to a “no” answer to any of the 88 questions?** Review this list with your family or fellow occupants of your residence at least once a year. Stay security conscience and remain safe.



# LOCKS

Beyond the **need** for locks, which is obvious, many considerations need to be made as to the type of lock, their purpose, and the safety issues involved in someone getting in **and** out of a locked door or window in case of an emergency such as a fire or natural disaster. The overall **best** lock for the purposes of securing your residence is a **single-cylinder deadbolt lock** that opens from the outside with a key and from the inside **with** a simple **thumb** pinching and **turning** with your hand and without a key. Unfortunately, these locks are not common in most homes.

## We will first examine the various ways in which a burglar may open a door:

- These are limited only by the ability of the burglar and the amount of time he has at his disposal. Remember, delaying a burglar is one of your best deterrents. There are many ways that a lock can prove meaningless to a burglar who:
- Finds the door unlocked.
- Has a key, from the previous owners or tenants, or finds it under door mats, in flower pots or the mail box, or over the door.
- Removes or breaks glass in the door and reaches inside and opens the door.
- Jimmys or pries the door open with a crowbar or other tool.
- Gets the victim to open the door and foolishly relies on a useless chain latch.

- Splits or spreads the door frame by kicking in the door, usually at the lock area, or by the use of tools.
- Finds a door with plywood panels which can easily be kicked in, the door unlatched or simply crawls through the opening.
- Uses a pipe wrench, hammers the door knob or pulls the key cylinder plug with a slide hammer dent puller.

Most of these ways can be prevented with a little common sense. Not all, though, and here is a rundown of locks:

## Spring Latch Lock

If you use this as the sole means of security, you might as well not even close your door.

As you close the door, the latch springs into place. A simple shim is placed between the door and the frame, causing the latch to retract and the door to open. The technique is so simple the most inexperienced burglar can almost walk through the door.

A deadbolt lock must be added to provide security. A spring latch lock by itself is virtually worthless for security.

## Cylinder (Key in the Knob) Lock

These are not adequate for exterior locks. They are best used for interiors and privacy, such as closets and bathrooms.

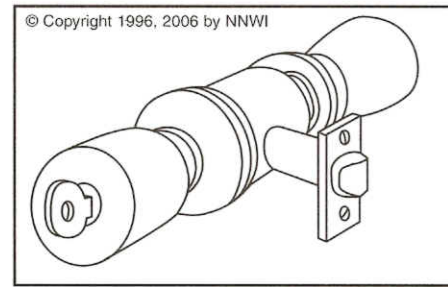

Easily can be opened with credit cards, a dent puller or pipe wrench.

## Deadlatch Lock

These locks are equipped with a dead-latching or tripper pin that is attached to the bolt. When the door is

closed, this pin is depressed. With the pin in this position, the bolt is immobilized. This lock is somewhat better than the spring latch lock, it is still vulnerable to prying, twisting or pounding.

A deadbolt lock must be added to provide security.

## Single Cylinder Horizontal Deadbolt

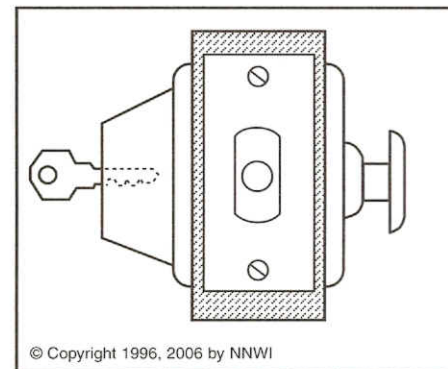

Keyed on the outside of the locking cylinder with a thumb turning latch on the inside.

deally this lock would have a minimum 1" throw of the deadbolt, the deadbolt would have a case hardened steel insert in it to prevent cutting, the cylinder guard would be of case-hardened steel, tapered and free turning.

The thumb turn on the inside eliminates the need for a key, as is the case with a Double Cylinder Deadbolt Lock. This is great for safety, especially in case of a fire.

***This lock, with a solid core door and no nearby windows or your best security.***

However, if your door has a window or there is a window within arms reach of the thumb turning latch, your security is compromised. Weak doors coupled with this lock also compromise security.

### ***Double Cylinder Horizontal Deadbolt***

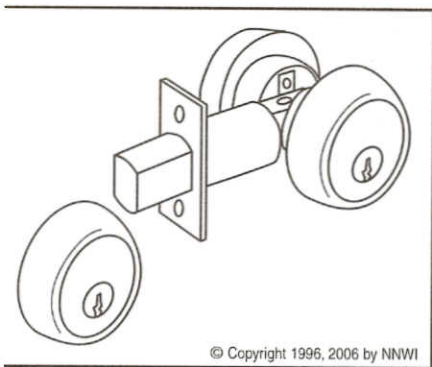

Keyed on the inside and the outside of the locking cylinder.

Only appropriate for non-residential settings, such as businesses or toolsheds.

Does not allow easy exit to burglars who have hidden in a business until after-hours.

Many building codes make this type of lock unacceptable for residences because of the need for a key in case of emergency exiting.

### ***Double Locking Deadbolt***

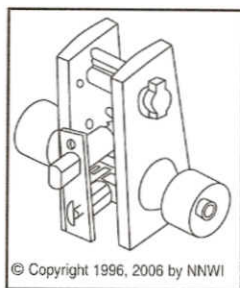

Combination of a half-inch throw deadlocking latch and one inch throw deadbolt with a concealed steel roller

that resists sawing or prying.

The lock mechanism is protected by an armor plate under the ornamentation, making it resistant to drilling, sawing or piercing.

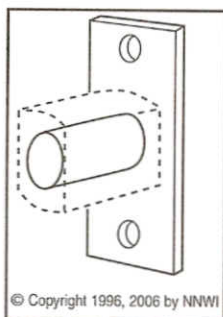

When the door is locked, the outside knob is free-spinning, so that it is impossible to get leverage on it to force or twist it.

The recessed cylinder discourages forceful entry.

### ***Single Cylinder Vertical Deadbolt (also known as a Rim Lock)***

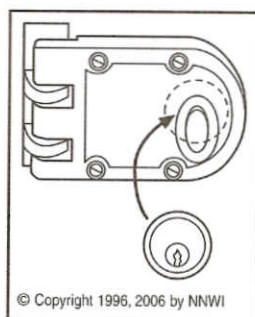

Keyed on the outside with a thumb turn on the inside.

Extremely resistant to prying or cutting.

Mounted on the surface of the door as opposed to single or double cylinder deadbolts which are mortised.

If your door has a window or there is a window within arms reach of the thumb turning latch, your security is compromised. Weak doors coupled with this lock also compromise security.

### ***Buttress-type Lock***

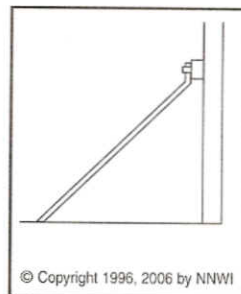

If the frame can not be strengthened or reinforced, as in an older building, this type lock should be used with

a long steel bar that sticks into a floor receptacle and wedges against the inside of the door. In this way, the strength of the door is being used instead of the frame.

It is important that the bottom of the door fits closely to the floor to avoid the steel bar being removed from the floor receptacle by an intruder.

### ***Cremone Bolt***

A device of surface application that by a turn of a knob or lever handle locks the door or sash into the frame, top and bottom.

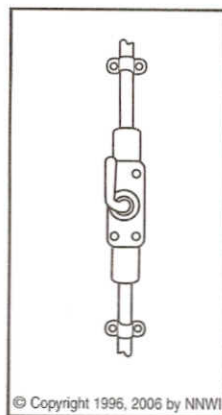

### ***Flush Bolt***

Very similar to cremone bolt except that the bolts are operated independently, top and bottom. Is usually used for double

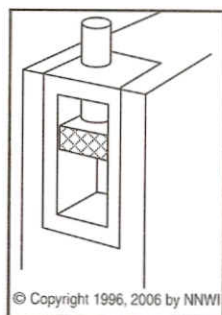

doors, with bolt installed on the inactive door. When applied, bolt is flush with the face or edge of the door.

Flush bolts offer additional security since the intruder cannot get at these devices to tamper with them if the doors are locked.

## Cross Bar

Useful for a door which is seldom used or is not required as an emergency exit. Heavy hooks holding a

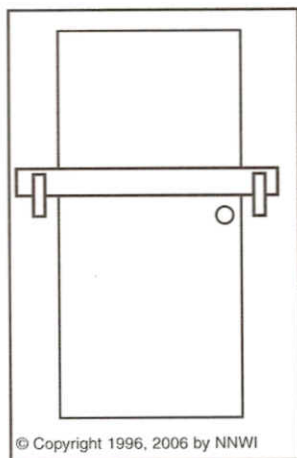

heavy cross bar provide excellent security when padlocked. If the door is never used, the cross bar can be bolted to the hooks.

The cross bar should be secured to the hooks so an intruder can not easily use the door as an exit, or pry the crossbar off by slipping a tool between the door frame and the door in order to lift the cross bar.

## Strike Plate

A reinforced strike plate is necessary for good locks to perform well. Strike plates can be reinforced

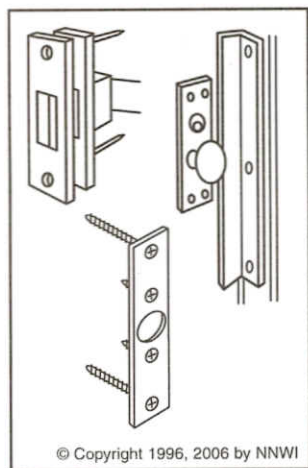

by using screws long enough to reach past the trim and into the studs, at least 3"-5". The strike plate should have at least four screw holes, and screws run through each hole into studs.

An added precaution would be the attaching of a piece of heavy-gauge sheet metal to the door frame for about 16" This will reinforce the lock area and

make it more difficult for someone to overcome the lock by kicking the door in.

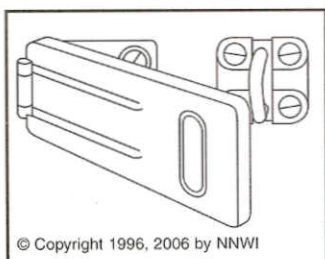

## Hasps

Hasps are fastening devices consisting

of a loop and a slotted hinged plate. The placement of the hasp high up on the doorway will make it more difficult for an intruder to manipulate the lock going through the loop. Hasps should be very securely bolted or secured into place, so that the heads of the screws are completely covered when the hasp is closed.

## Padlocks

A good padlock should be of case-hardened steel, have heel and toe locking features and constructed so the key can not be removed unless the padlock is in the locked (closed) position. Identification numbers should be recorded and then obliterated on the lock casing.

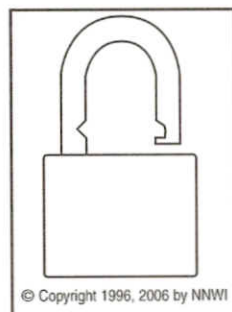

## Panic Bars

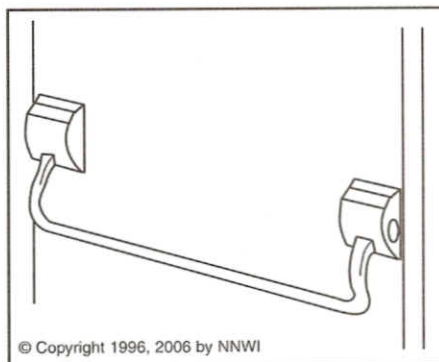

Where a doorway in a public area must be available for an emergency exit, but not for

entrance, it can best be secured with a panic bar. There is no lock visible on the outside. A simple push on the bar from the inside actuates a Cremona bolt (top and bottom) or a center latch, allowing the door to swing outward.

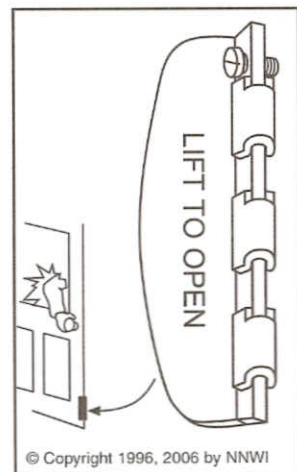

## Flip or Nib Lock

This type of lock, when installed properly with wood screws of at least 1-1/2" length

and located out of reach of any windows and small children, provides good additional security. A flip or nib lock has two sections, one attached to the door and one to the frame. A metal flap extends out from the frame and swings into a locked position on the door.

## Common Chain Locks – Last and Definitely Least!

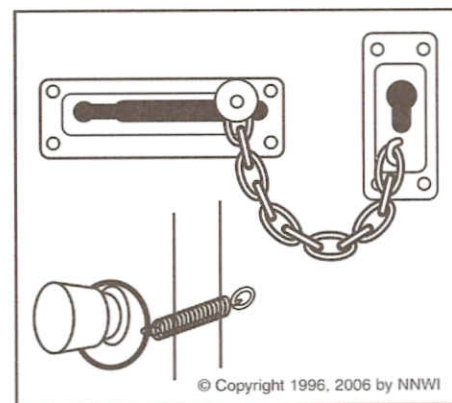

Easily defeated with a kick or strong push, the chain is usually very weak and the screws holding the lock are almost always too short. Extra-heavy duty varieties may be available, and if properly installed could be effective. Not recommended.

# DOORS

## Solid Core Doors

This type of door is solid wood throughout. This door can be distinguished from a hollow core door by its weight and solid sound when knocked on. Because there is no glass in the door, it is recommended that a

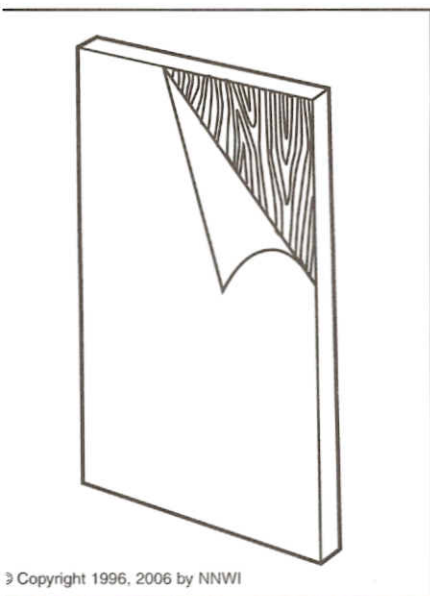

wide angle viewer, with good peripheral vision (180 to 200 degrees) be installed to observe callers. **With a single-cylinder, horizontal deadbolt lock installed, this is your best choice for external door security.**

## Metal Doors

More commonly found in commercial businesses and industrial locations, they consist of a medium gauge sheet metal welded together and pre-drilled for spring-latch locks, but not usually for an auxiliary deadbolt lock. If they can be obtained with a drill hole to accommodate a horizontal deadbolt lock, they would be second among the choices for security. Usually more expensive than solid core doors, they have been known to bend inward under sufficient impact rendering the lock useless.

## Panel Doors

These doors are basically solid in the main structure of the door, but they are compromised

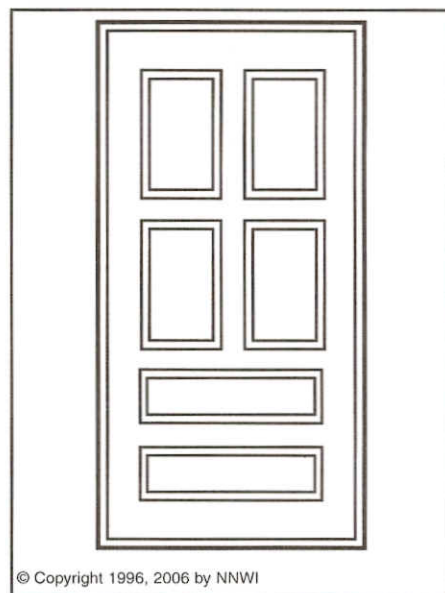

by varying designs of beveled panels, which create thinner portions of the door, which are vulnerable to breaking through. If this door is used for exterior purposes, it is advised that the panels be at least 1/2" in thickness or reinforced to an equivalent strength. These are not as strong as solid core doors.

## French Doors

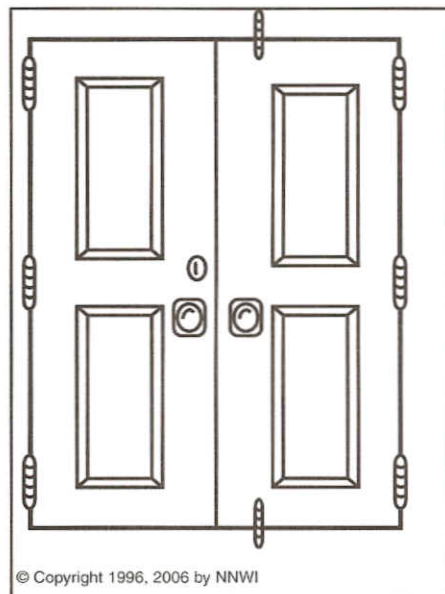

These doors are very weak. They often have glass, are very attractive but they offer no degree of security. They can be compromised with a little pushing or kicking. A minimal amount of

# KEYS

**In over half of all burglaries in the nation, entry into the house was not forced. Doors and windows were left open and KEYS WERE AVAILABLE.**

Here are important tips on keys:

- 1 Never hide your key outside. Burglars know all the hiding places.
- 2 Never carry identification tags on your key ring or holder.
- 3 If you valet park your car, use a separate key for parking which does not have your house key with it. An unscrupulous parking attendant can have a house key made within just a few minutes, and with your car registration at hand, it is a simple matter to put the two together.
- 4 Moving into a new home or apartment? Change the locks as soon as you are moved in. A locksmith can do this inexpensively or if you are handy with tools, you can do this yourself in a matter of minutes.
- 5 Know who has every key to your home. Don't give keys to maintenance or delivery people.

security can be obtained from cremone or slide bolts going into the header and threshold, with at least a 1" throw. If hinges are on the exterior of the door they should have non-removable pin type hinges.

### Hollow Core Doors

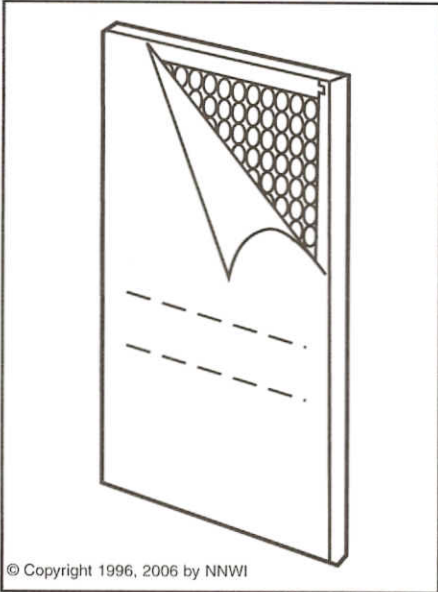

This door is typically made of two veneer wood panels covering an interior of cardboard or other material acting as a spacer. The outer frame and a block for mounting the lock are virtually the only solid components of the door. This door can be distinguished from a solid core door by its lack of weight and dull sound when knocked on. These are only recommended for interior use, such as for closets, bathrooms and other rooms such as bedrooms that need to be latched, but not seriously secured against intruders. This type of door can be easily kicked in, leaving a hole through which any locking device is accessible. If you can not replace this type of door with a solid core door, this hollow core door can be reinforced with an additional layer of 1" exterior plywood bolted to the door.

### Doors with glass, or glass within 36" of the door

Install a non-breakable glass replacement such as Lexan, or security film such as Armor-Coat.

### Sliding Glass Doors

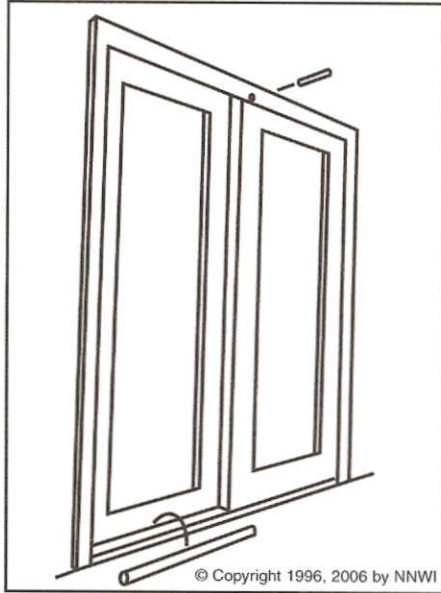

These doors move horizontally on tracks. The moving door typically moves on the inside track, but not necessarily so. Locks are usually inadequate. If the door slides on the **inside** track, a dowel placed in the track will prevent the door from being slid open. (See illustration above.)

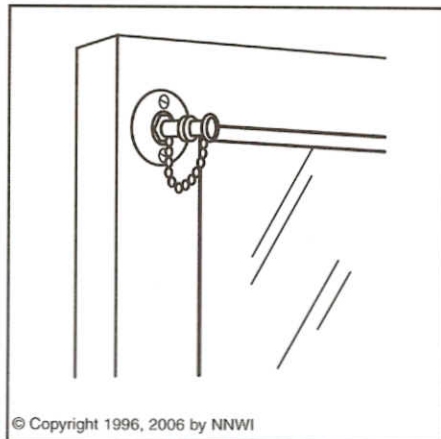

Another option would be to drill and pin through the overlapping frames and installation of a removable pin. (See illustration above.)

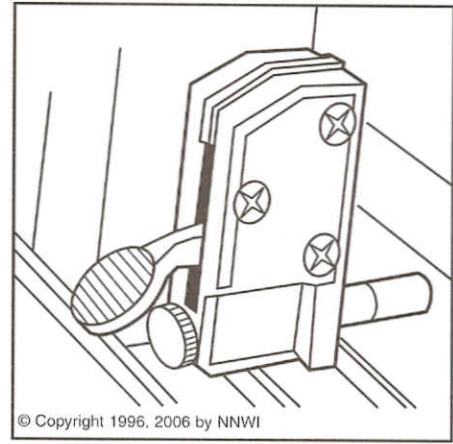

If the door slides on the **outside** track, you are best installing a keyed slide bolt. (See Illustration above.)

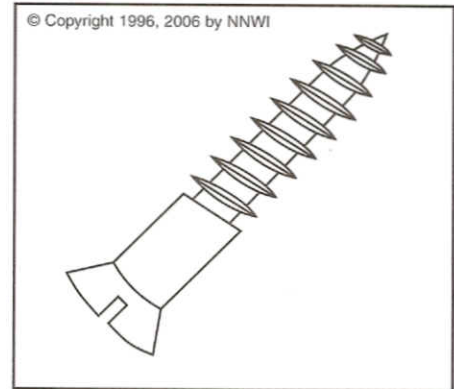

To prevent the door from being lifted out of its frame, a common move for burglars, install screws in the upper track so the screw heads protrude just enough to clear the sliding door when it is closed. (See Illustrations above and on page 16.)

### Door Frames

Door frames either pre-hung, or framed in. Since a lock is intended to keep the door secured to the frame, a strong frame is extremely important. Since most homes built since World War II (1946 and later) have a pre-hung door frame, you might want to do the following:

See if the door frame is mounted securely. Remove the interior door molding and see how much gap, if any, exists between

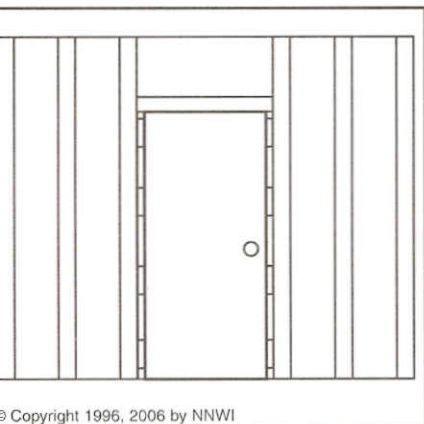

© Copyright 1996, 2006 by NNWI

the door frame and the building studs. Shims are generally used to square and plumb the door and often a gap exists between them. Add shims, if possible, between the door frame and the studs to give it extra strength, especially around the area of the strike plate and its lock. Use high security strike plates on this type of door construction. They should be at least 4" long, with 4 screw holes. The screws should be long enough to reach the studs. In some homes, older and custom homes, will have frames that were built as part of the wall.

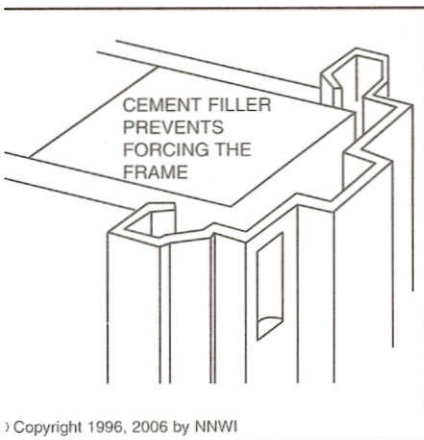

© Copyright 1996, 2006 by NNWI

This type of construction is extremely strong and is difficult to kick in when a 1" deadbolt is used. Hopefully no gap exists between the door frame and the building studs.

### Door Hinges on Exterior Doors

Doors with exposed hinges and exterior security door hinges

should have pins welded in place, drilled and pinned, or replace the hinges with non-removable-pin type

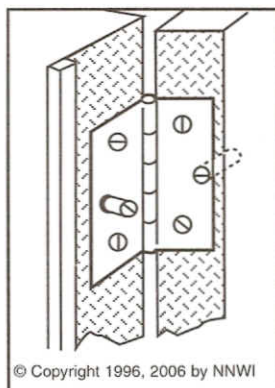

hinges. Interior hinges should have non-removable hinge pins so as not to allow an easy exit for the intruder. This is only applicable to commercial prop-

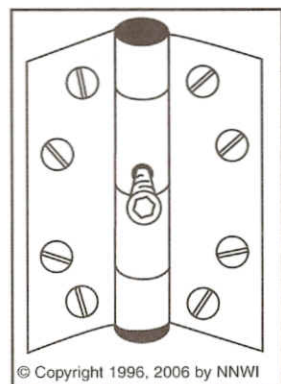

© Copyright 1996, 2006 by NNWI

erty, since residences should always be openable from the inside, as a fire safety measure.

### Mail Slots

Mail slots should be no larger than 2" wide, not within 30" of a door and always angled downward to prevent a burglar from being able to reach through the slot to open the door.

### Garage Doors

Garage doors should be kept closed at all times whether you are in the home or away. They should only be open when you are working in and about the garage, or moving a vehicle in or out. If a burglar gets into your garage, and your garage is attached to your house, he has plenty of time to gain entry into your home through the connecting doors because he will be out of sight of your neighbors. Add to this predicament a number of tools you probably have in the

garage to assist in a break in. Even passers-by walking, jogging or bicycling by your open, unattended, garage are faced with temptation.

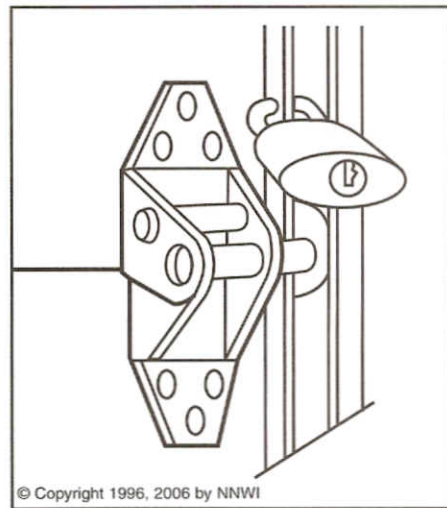

© Copyright 1996, 2006 by NNWI

To secure your overhead garage door, drill a hole through the track above a roller, or through the end of the deadbolt latch that protrudes through the track. Insert a heavy bolt or case-hardened padlock. Thin door panels should be reinforced. Windows should be covered to prevent someone from looking in to determine if anyone is home or if any property inside is worth stealing.

Garage doors that swing out horizontally can be secured by installing surface bolts at the top and bottom of one door and a hasp and padlock on the outside or inside of the doors.

If you have, or plan to install, an electric garage door opener, it should be of the electronic digital code variety, so that the door will not accidentally open by random sounds. Check the door periodically to make sure that it is engaged and can not be lifted from the bottom. If you will be away for an extended period of time, disconnect the garage door opener.

# WINDOWS

## Security for Double-Hung or Sash Windows:

The two significant weaknesses in this type of window concern the center closing latch. The glass can be broken and the latch opened. The latch can be pried or forced off the window with a pry tool from the outside. This type window can be secured by:

### Drilling and Pinning:

With the window in a closed

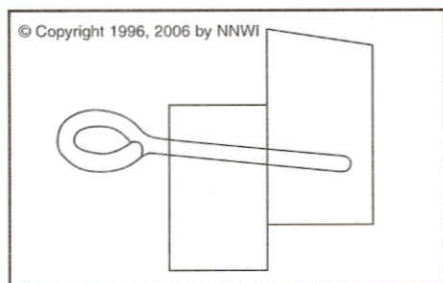
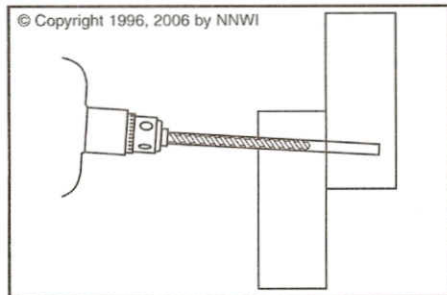

position, from inside the house, drill a hole in the two overlapping corners of the inside sashes. These two holes should be drilled on a downward slant and the drill hole should continue into the second sash,

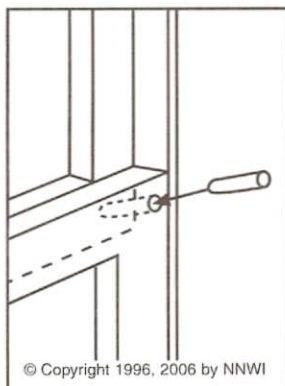

without passing all the way through to the outside. Insert double-headed nails into these holes. This effectively secures the window against intruders, while allowing easy exit in case of fire by pulling up the nails. A second pair of holes can be drilled above the first holes to pin the window slightly open to provide ventilation.

### Vertical Rods:

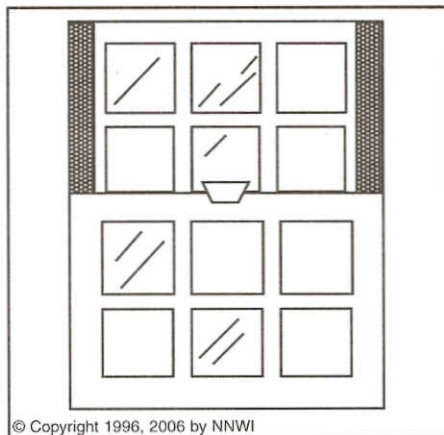

With the window in a closed position, place dowels, rods or boards in the inside vertical track. These should be placed on each side of the window interior to make it difficult for the intruder to pry the window open. The dowel, rod or board should be sufficiently strong to prevent breaking by being squeezed vertically when an intruder tries to lift the window.

### Diagonal Rod:

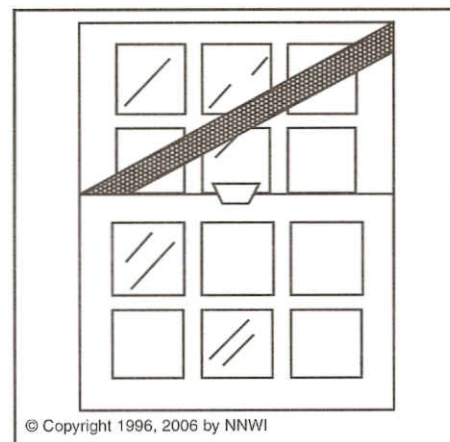

Place the dowel, rod or board diagonally across the inside of the window.

### Key Latch:

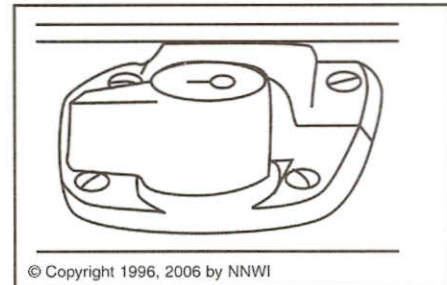

Consider replacing the unkeyed latch with a keyed one. It should be secured with at least 3/4" screws to prevent it from being easily pried off. These windows should only be locked when the house is vacant. Windows need to be kept accessible in case of fire when you are at home.

## Security for Sliding Glass Doors and Windows:

Sliding glass doors and windows are generally made of aluminum and can easily be forced open with a pry bar or screwdriver, then removed from the outside by lifting the door or window above the metal lip of the track and then pulling out.

### Drilling and Pinning:

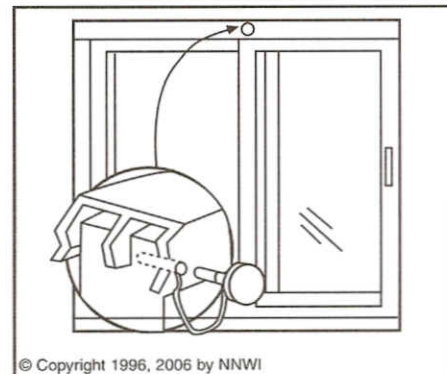

With the door or window closed, drill a hole through the center of the inside frame and part way

through the outside frame. Then place a pin or nail through the hole. This will prevent the door from being forced open or lifted from its track.

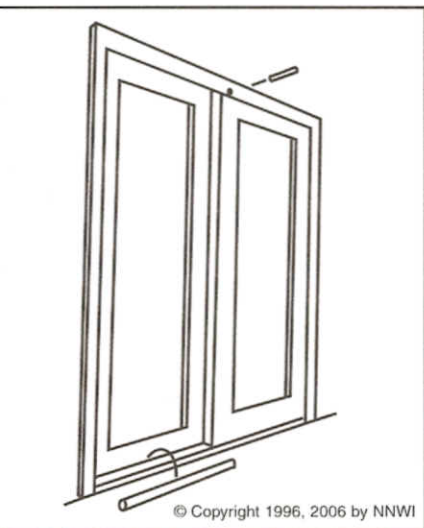

### Board or Rod:

With the window or door closed, place a dowel, rod or board in the inside track. This will only help if the moving door is installed on the inside track while the stationary door is on the outside. Charlie bars, aluminum rods that are designed for this purpose are available at most hardware stores. Make sure the rod fits snugly.

### Adjustable Screws

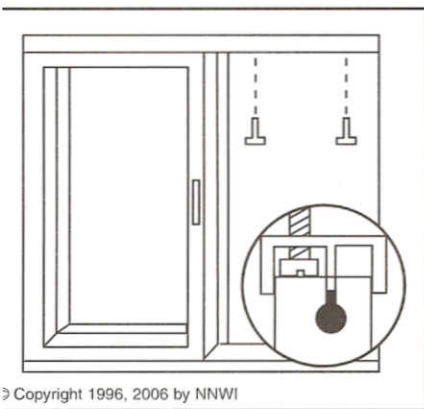

### in the Upper Track:

With the door or window open, drill holes and install several screws in the upper track. Adjust

them so that the window or door just barely clears the screw-head. This method is designed only to prohibit the door or window from being lifted from its track.

## Security for Basement, Garage and Door

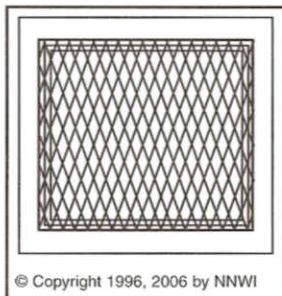

## Windows:

Don't seal off windows in such a manner that you create a fire trap in your home. One window per basement room needs

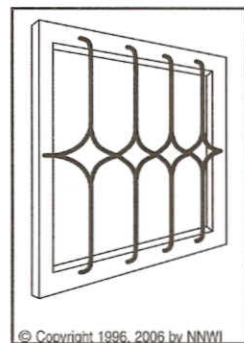

grill work.

Wherever possible, install so that windows can still be opened for emergency exit

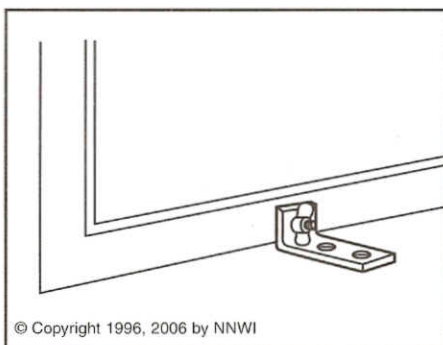

to be open-able as an emergency fire exit. Basement windows can be covered with 12 or 19 gauge expanded metal or ornamental

purposes.

A length of metal pipe installed on the inside of the house can secure a basement window.

### Casement Windows:

Remove crank and/or add an angle iron, carriage bolt and

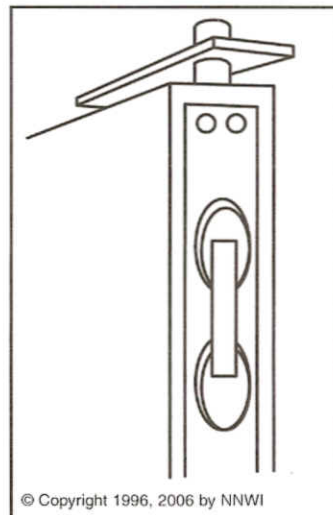

wing nut.

### French

### Windows:

Secure with self-mounted flush bolts at the top and bottom of each window.

### Hinged

### Windows:

Secure with a flush bolt or surface bolt.

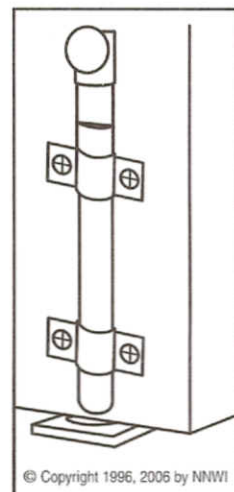

### Louvered

### Windows:

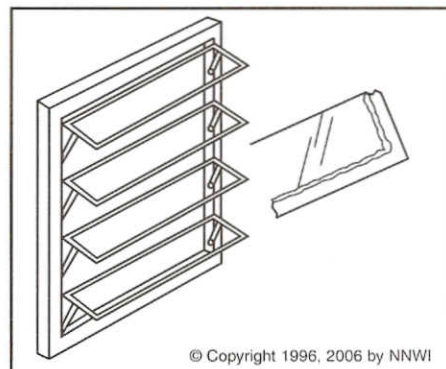



# ATM PRECAUTIONS

**A**utomated Teller Machines (ATM's) are very commonplace today, offering convenience to users and opportunities to criminals. Although not a usual part of Neighborhood Watch activities, you and your neighbors no doubt use these machines.

## Here are a few precautions you need to take:

**1** Prepare for your ATM transactions at your home or office to minimize your time at the ATM.

*Example:* Fill out deposit slips and have the bank's deposit envelopes available at your home or office.

**2** Mark each transaction in your account record, but not while at the ATM.

**3** Always save your receipts. Don't leave them at the ATM because they may contain important account information.

**4** Don't lend your ATM card to anyone.

**5** Remember, do not leave your card at the ATM — especially in the machine.

**6** Protect the secrecy of your Personal Identification Number (PIN).

*Examples:* Don't tell anyone your PIN. Don't write your PIN where it can be discovered. Don't keep a note of your PIN in your wallet or purse. Especially, Don't write your PIN on your ATM card.

**7** Prevent others from seeing you enter your PIN by using your body or other hand to shield their view.

**8** If you lose your ATM card or if it is stolen, promptly notify your bank and your local law enforcement agency. Keep the phone number of your ATM and credit card companies handy, at home or your in office, so you can notify them immediately if your card is lost or stolen. Your NNWI Household Inventory Form asks for this information. Use it.

*Tip:* Most credit card companies offer an annual notification service for a nominal fee (about \$35) and will notify all your card providers if a card is lost or stolen. This is a good value since they will usually provide a timely service to insure you against additional loss through fraudulent charges.

**9** At the ATM, be especially mindful of your surroundings. Look out for suspicious activity near the ATM facility. At night be sure the ATM site, the parking area and walkways are all well lighted. It may be wise to bring someone with you when you make a transaction. If you observe anything unusual, go to another ATM facility.

**10** Don't accept assistance from anyone you don't know when using an ATM.

**11** If you notice anything suspicious or any other problem arises after you have begun an ATM transaction, cancel the transaction, pocket your card, and leave.

**12** Wait until you are in secure surroundings to count your cash.



© Copyright 1996, 2006 by NNWI

**13** If you are held up after you get your cash, throw the cash on the ground and run, screaming, for help.

**14** At a drive-up ATM, make sure all the car doors are locked and all of the windows are rolled up, except the driver's window. Be mindful of #1 above, be prepared. Keep the engine running and remain alert to your surroundings.

**15** If you are held up after you get your cash at a drive-up, and someone blocks your path, run them down.

**16** The ATM should be safe and convenient for you. Tell your bank of any problem with an ATM facility. Report any suspicious activity to the bank and to the police.

*Examples:* A light is not working which they would not notice during the daylight hours of operation. Damage to the machine from the outside. Vandalism such as graffiti. Suspicious individuals loitering near the facility.

**17** ATMs are here to stay. Practice these precautions at the ATM facilities where you bank, and also at point-of-purchase sites where you may purchase gasoline or your groceries.

# MINIMIZE CAR JACKING RISKS

**T**hrusting a gun in your face and taking your car while you are in a parking lot, at a traffic signal, getting gas, or simply waiting in your car is called Car jacking and it can happen to you.

Here are 19 common-sense precautions you can take to put the odds in your favor:

## **Before you enter your car:**

- 1** Be alert to any activity near your car.
- 2** If there is someone loitering near your unoccupied car, keep walking until they leave.
- 3** Pay attention to your surroundings.
- 4** In a parking lot, approach your car by walking toward it in the center of the driving lane, not at the side where someone could leap out from between cars.
- 5** Walk with a purpose.
- 6** Don't walk aimlessly towards your car. Have an alternate route in mind in case of problems.
- 7** Always have your key in hand and check the back seat and locks before entering.

**8** If someone demands your car, especially with a child in a car seat, gain time by asking to get your child out, holding your keys momentarily and then throwing them away, preferably under another parked car.

**9** If you are confronted, do not resist.

**10** **NEVER** get in a car with a car-jacker. Scream, run, do everything you can to avoid getting in your car.

## **Once in your car:**

**11** Lock and start your car immediately. Keep doors and windows locked.

**12** If someone threatening you blocks your pathway, run them over.

**13** Stay out of high crime areas, especially at night.

**14** Be suspicious of people approaching your car asking for directions, change, or giving out flyers.

**15** When stopping in traffic, leave enough distance between your car and the car in front of you, so you can pull away quickly, and carefully, if necessary.

**16** If a suspicious person approaches your car, drive away quickly and carefully - even if you must go through a traffic light. *Of course, be careful to avoid an accident.*

**17** If another vehicle bumps your car, or your tires goes flat, keep your doors and windows closed and wait for law enforcement to arrive - or put your flashers on and drive slowly to the nearest Police Station or populated area such as a store or gas station.

**18** Be especially alert when using drive-up automated teller machines (ATM).

**19** Always keep valuables out of view when traveling.

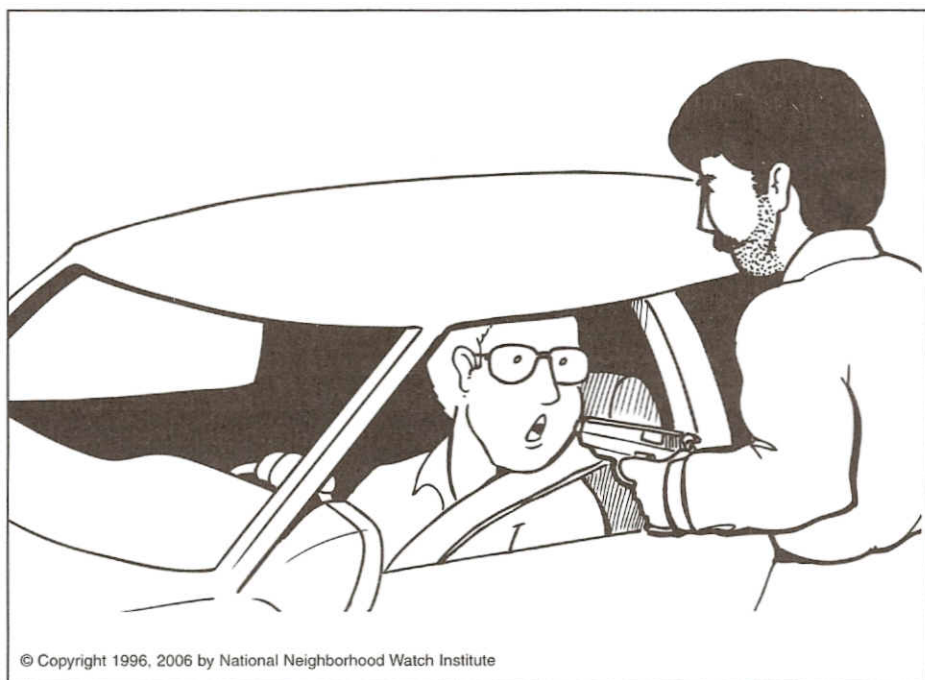

© Copyright 1996, 2006 by National Neighborhood Watch Institute

# APARTMENT AND OTHER MULTI-UNIT DWELLINGS

**A**partment and other multi-unit dwellers have most of the same security concerns as residential dwellers. Here a few tips that could be especially useful to you who live in these buildings:

**1** Lighting is probably the most important consideration in apartment security. Are halls, laundry rooms, stairwells, parking lots and the building exterior adequately lit?

- 2** Are storage areas, the basement, laundry rooms, and other common area tenant facilities well locked? Is there adequate control on the keys providing access to these areas?
- 3** Install deadbolt locks on all exterior doors. Tenants usually pay for these. Have the deadbolt lock be a different make than the door lock and don't master-key your lock to the management locks. You can give a friend a key marked "Do Not Duplicate" in a sealed envelope. Let your apartment manager or building superintendent know whom to contact in case of an emergency.
- 4** Look for special security and safety features in your building. If there are security or fire alarm buttons, be sure you know where they are. Know the nearest exit for use in an emergency.
- 5** Tell a friend, the apartment manager or the building superintendent when you will be gone for an unusual length of time such as a vacation or hospital stay. Leave an address or phone number where you can be reached.
- 6** Put lights, television and radio on programmable timers so a potential intruder will think someone is at home.
- 7** Know your neighbors. Set up your own Neighborhood Watch program with your neighbors and those in other nearby buildings. Look out for each other.
- 8** Join forces with your other neighbors to insist that management and owners provide adequate building security and safety if these are inadequate. Check local housing regulations to make sure your building complies in these areas.

---

Draw your own building's floor plan. Show hallways, doors, your personal emergency escape routes, locations of fire alarms, hoses and all other safety features. **By drawing and thinking through this entire process, and checking it over thoroughly, you will better be able to protect yourself in an emergency.**

---

# VACATION PREPARATION

**A** vacation should be a pleasant experience for you and your family. Take a few simple steps to reduce the possibility of a burglarized house while you are away. Here are 22 steps you should do in preparation for your trip, and even a few additional thoughts to keep in mind while you are on your trip:

## One or Two Days Before You Leave on Your Vacation:

- 1** Notify your newspaper to put your subscription on a "vacation hold" and give them a date to start delivering again.
- 2** Notify your local post office to put your mail delivery on a "vacation hold" and give them a date to start delivering again.
- 3** As an added precaution, ask a neighbor to pick up your newspapers and mail if your instructions were not followed. Also ask them to remove throwaway papers and circulars from your yard and doorway.
- 4** If you have valuables in the house, take them to your bank for storage in a safe deposit box or vault. Do not leave cash in the house. By

this time you should have engraved your valuables such as TVs, appliances, computers and other easily sold items prone to being burglarized.

- 5** Notify your local police or sheriff's department about your departure and return dates. Give them a name and telephone number of a neighbor or relative to notify in case of a burglary, fire or other emergency.
- 6** Make arrangements to have your grass cut and watered while you are gone, leaves raked, or your walk and driveway shoveled in winter.
- 7** Move all ladders, tools, lawn implements, garbage cans and yard furniture to your garage, basement or storage shed several days before you leave.
- 8** Arrange with your block captain, a neighbor or relative to watch your house. Give them a key and let them know where or how you can be reached in an emergency. Write their telephone number down so you can check with them during your trip. Give them your car description and license number.
- 9** Make sure any broken windows, window locks and door locks are repaired.

## On the Day You Leave:

- 10** Plug in timers to turn lights and a radio on and off at appropriate times. Give the appearance that the home is occupied when you are away.

- 11** Unplug all electrical appliances such as television sets, irons, washer, dryers and fans to prevent possible damage from electrical storms.
- 12** Set your thermostat so that your furnace or air conditions will maintain a reasonable temperature in your house. 85 degrees in summer and 50 degrees in winter are good settings. In winter, make sure outside water taps are drained to prevent freezing.
- 13** Close your fireplace flue to prevent birds or animals from entering.
- 14** Be certain all gas appliances are in good order and pilot lights are on.
- 15** Turn off water to automatic washer to prevent possible damage from a broken hose.
- 16** Turn off ringer on your phone so it cannot be heard from outside. Do not leave a message that you are away on vacation on your telephone answering machine.
- 17** Close all windows and sliding doors. Lock them. Place wooden dowels in all sliders so windows and doors can not be slid open. All screens or storm windows should be checked to be certain they are locked and fastened.
- 18** Make sure all main floor drapes, shades and curtains are arranged in their normal daytime position so that neighbors and police can see into your house. Even

better, ask a friend to close and open window coverings daily.

**19** Be certain any car or other vehicle you are leaving in your driveway is locked. If you take your only car, ask a friend or neighbor to park their car in your driveway.

**20** Lock your garage door. Disengage or turn power off to your automatic garage door opener.

**21** Make sure the last person out locks the door. If you have an alarm system, make sure it is turned on.

**22** Take a walk around the house. Check all the doors and windows.

**23** As you pack your luggage check for identification tags. If you will be checking in your luggage anywhere, only your business address and phone numbers should be available for identification - NOT your home.

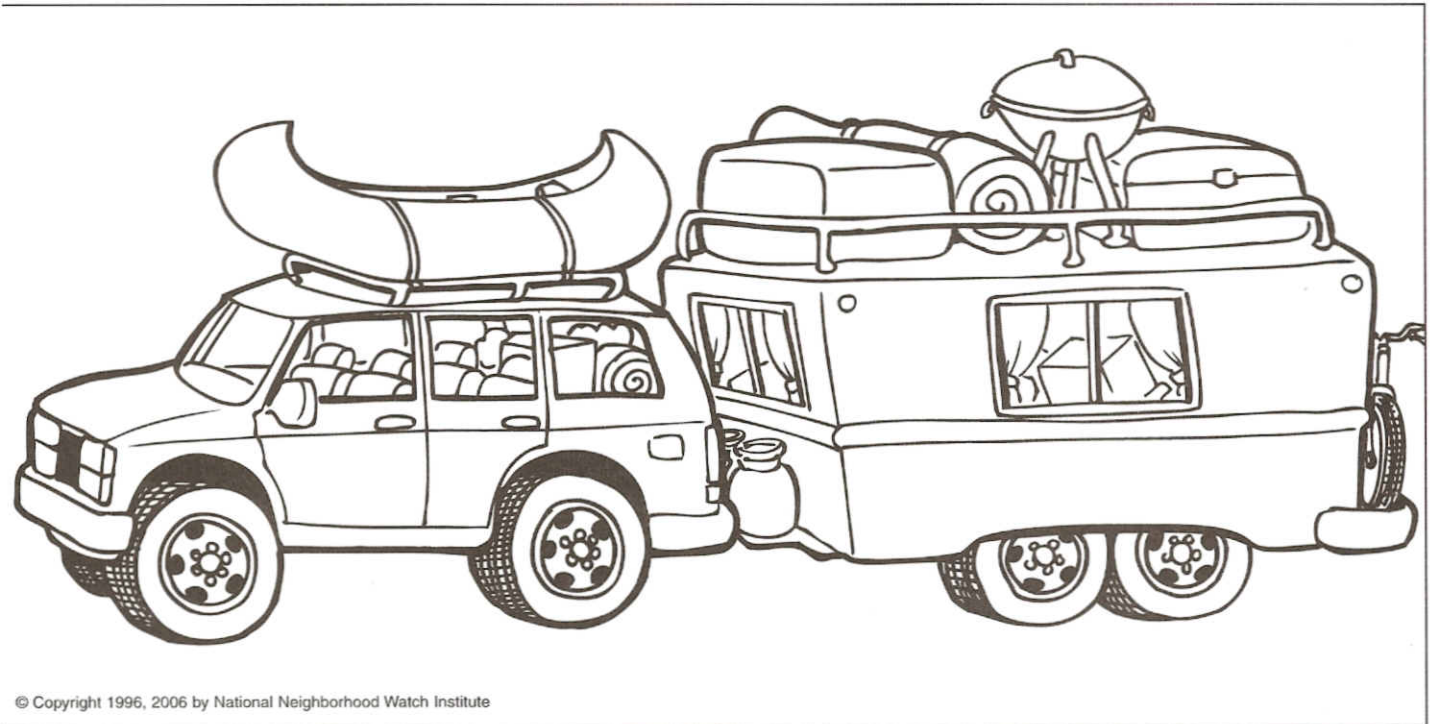

© Copyright 1996, 2006 by National Neighborhood Watch Institute

**Assuming you are driving, here are some additional tips:**

**1** Make sure your vehicle has been properly serviced and is in suitable condition for the journey.

**2** Try to have specific directions and routes to your destination.

**3** If you get lost, call the local police or sheriff for directions or assistance.

**4** Always keep your vehicle doors and windows locked.

**5** At stop lights and other traffic delays, leave enough space in front of your vehicle so that you have an escape option in case of an emergency.

**6** Let someone know the route you intend to travel and your itinerary. This will help authorities in locating you if there is a need to do so.

**7** Plan your trip carefully and allow for factors such as weather, fatigue, facilities for lodging, food and fuel.

**8** Be sure you have sufficient finances, either cash or credit cards.

**9** Ask the hotel or motel staff about their security measures so you know what to expect.

**10** Use the hotel or motel safe to store your valuables during your stay.

Travel safely and relax, have fun and be safe. Enjoy your vacation...and return to your home in the same condition you left it.

# HOLIDAY SEASON

**T**he holiday season is a time when busy people become careless and are especially vulnerable to theft and other crimes. Here are a few crime prevention tips which will enable you to keep your holiday a happy one.

## While Shopping:

- 1** Lock your packages in your trunk while you shop.
- 2** Lock your car and close the windows, even if you will be away for only a few minutes.
- 3** Stay in busy, well-lit, places. This is especially necessary if you are waiting for public transportation.
- 4** While shopping with children, teach them to go to a store clerk and ask for help if they become separated. NOT to a stranger. Show young children they can identify a store clerk by the fact that people are paying them money and the clerks are packaging the things being purchased.
- 5** Young children should never go the parking lot alone. Never leave them inside a car with the windows rolled up.

- 6** Avoid carrying cash. Use credit cards as they are accepted by most stores and are processed almost immediately. Checks require more patience and identification — and are increasingly unacceptable to merchants.
- 7** Be extra careful with purses and wallets. They become targets for crime in crowded shopping areas, at bus stops, on buses and rapid transportation. If you feel a bump by another person, check for your purse and wallet instantly. Use fanny packs because they leave your hands free, are less bulky and can be carried with ease.

## While Partying:

- 8** **Never drink and drive.** Remember, only abstinence and time will make your body alcohol-free. If you do drink, designate one of your party to stay totally sober.

- 9** If you are the host, have non-alcoholic beverages available for your guests. Measure the amount of liquor being poured by using a 1-oz or 2-oz shot glass rather than pouring from the bottle. Liqueurs may be tempting to small children because of their sweetness — the alcohol in them could be deadly. Be careful.
- 10** Serve meat, cheese, eggs or other high protein foods which will stay in the stomach longer and slow the absorption of alcohol into the system. Always have something to eat before you drink.

- 11** Coffee makers, crock-pots and all small kitchen appliances should be unplugged when not in use.

## Around Your Home:

- 12** Be fire safe, especially with your Christmas tree. Make sure lights are in good working order. Be certain that the tree is kept moist with a base containing water, use a fire retardant in the mixture solution — and check that base every few days. A pine tree will absorb a tremendous amount of water. Replenish it. Never put your tree in your fireplace, it is like a bomb when it burns. Ask your local fire department for more information.

While on the subject of trees:

- a)** Be sure doors and passageways are not blocked by your tree.



**b)** Be sure your tree is in a sturdy base so that small children or pets can not tip it over.

**c)** NEVER use burning candles on your tree.

**13** Never leave lit candles unattended. Check decorations for flame resistance and never assume they are flame retardant.

**14** Be security conscious by locking doors and windows when you leave your house, even for a few minutes.

**15** Leave lights and a radio or TV on so the house appears occupied.

**16** Do not put large displays of holiday gifts in view of your windows or doors.

**17** If you go away for the holidays, get an automatic timer for your lights, TV and radio.

**18** Have a neighbor watch your house. If away for just a few days, have your neighbor pick up your mail and newspapers. If you are away for more than a few days, stop your newspaper and put your mail on a "Vacation Hold".

**19** Are there valuable new possessions in your home? Mark them with your state and drivers license number or photograph them for your permanent records. (See Operation Identification on Pages 28 and 29.)

**20** Remove and store your ladders. Don't invite burglary.

**21** And don't forget the seniors and shut-ins in your neighborhood who might be especially lonely during the holidays. They are frequently the observers in your Neighborhood Watch who are most likely to protect your property.

# HOME ALONE: LATCH-KEY KIDS AND BLOCK PARENTS

**O**ld, well established neighborhoods have become the exception rather than the rule in communities everywhere. Because of the highly transient nature of many Americans we have become increasingly unfamiliar with one other. Our kids frequently are home alone because both of their parents are away at work.

At the top of the list of Neighborhood Watch projects is establishing a Block Parent system for our kids. Identify homes where children know they can go when they need help, where it is safe, and when their own parents are not home. Place signs in the windows of selected houses so that children can find them easily. Ask parents to introduce their children to these Block Parents before emergencies arise.

In the minds of most parents, safety and security for their children is of the highest importance. Unfortunately, an innocent child probably will not think about safety and security on their own. Parents, Teachers and Block Parents must train chil-

dren how to be safe and secure after school. Here are a few things they need to know:

Children should walk home in groups, as much as possible.

Children should never take a ride from someone they do not know extremely well.

Children need to be observant on the way home and be aware if an adult follows them.

Children should never talk to strangers and, especially, never give their name and address to a stranger.

You should be certain they know their address and phone number, and how to dial 9-1-1 if someone follows them.

Hide the house key under their shirt or blouse. Key(s) should never be exposed advertising kids will be home alone. Keep phone numbers of neighbors and relatives, and your work phone numbers, where they can be easily found.

Teach them to always lock the door after they come home. Train them on what information to give on the phone.

If possible, they should check in with an adult neighbor, or their Block Parent if one is in place, in person or by phone when they get in.

And if you, as the parent, are the last one out of the house, before YOU leave for work, be sure that the house is completely locked, including all doors and windows. You don't want your child to come home to a house that has been burglarized, or worse, have them come home to a burglary in progress.

# BATTERED WOMEN

anger, blaming, arguments and increased tension. This leads to a violent outburst, *phase two*, which can include physical battering, sexual abuse, verbal threats or abuse or property destruction. Usually, this is followed by *phase three*, “the honeymoon” stage where the batterer is filled with remorse, apologies and reconciliation. This can last from months to weeks to hours.

## *Here are some options to consider:*

**Shelters** are safe houses where battered women can stay for short periods. They can also bring their children with them.. These houses are especially for battered

women. The whereabouts of the houses are now known to the general public and so there is little chance of the abuser finding his victim(s).

**Restraining Orders** are orders from the court telling the abuser to stay away from his victim, or he will have to face consequences such as jail. A restraining order can be obtained at the courthouse in your local jurisdiction. When called to the scene of a battering incident, the local police or sheriff can issue an emergency restraining order good for 3 days. There are restraining orders that force the batterer to move out of the residence — this type of order is called a “kick-out” order.

**A beating victim** should call the police or sheriff and upon seeing evidence of visible injury, the police will arrest the abuser. If the victim has a restraining order and the abuser violates it, the police should be called to arrest him.

**Relocation** is another option. If the battered woman and her partner have separated, but he is still bothering her and she fears him, she may need to move to another part or out of the city, or even out of the state. If he knows where she works, he may follow her home from her place of work. The victim may need to change jobs. If she feels that this is not fair, she's right; it isn't. But it may be the only way to keep her children safe.

**Monitored visits of the children** can also help. If the abuser has visitation rights or joint custody, the abused partner has the right to request an arrangement (through conciliation Court) whereby their safety is protected.

**Y**our partner is a Batterer if he or she exhibits a behavioral pattern that has been described as a **cycle of violence** with three phases. During *phase one*, or tension building, you will see

## Remember, ***YOU HAVE RIGHTS!!***

- **You have the right** not to be abused or battered.
- **You have the right** to request and expect assistance from social service and law enforcement agencies.
- **You have the right** to initiate civil action against the offender in the form of “stay away”, and/or restraining orders.
- **You may also sue** for injuries and monetary losses.



As examples, through monitored visits, or exchanging the children in a public place, etc.

**Self Defense training** can teach the abused partner to be assertive and build their confidence. There are classes especially geared for women.

**Safe-proofing the home** is very important. Making sure the locks are strong deadbolts and engaging a neighbor's help by letting them know they can call the police if they hear fearful noises or see the abuser hanging around the premises. Neighborhood Watch can make a difference.

**Important documents** should be kept in a safe place. Keep copies of the originals where they are readily accessible to you.

**If you have been sexually abused**, get to a safe place and call the police or sheriff immediately. Help is available. If you approve, a police officer or sheriff's deputy will notify the rape victim counseling center of your choice. A counselor is available 24-hours a day and at your request and will respond and accompany you to the hospital and/or police or sheriff's department.

# SEXUAL ASSAULT

**R**emember, sexual assault can happen to anyone, anywhere at any time! The typical stereotype of a sexual assault suspect is a sex-crazed maniac or psychopath. In reality, people who sexually assault are not strangers to their victims. In close to one-half of reported cases the rapist is an acquaintance, neighbor, friend or relative.

Although sexual conduct is a component of this crime, suspects mainly want to hurt, humiliate and degrade another human being.

## *What you should do to prevent sexual assault:*

Always be aware of your surroundings. Stay in well lit areas as much as possible. Walk confidently, directly, at a steady pace. A rapist looks for someone who appears vulnerable. Walk on the side of the street facing traffic. Walk close to the curb. In a parking lot walk in the center of the driving lane not near the parked cars. Avoid doorways, bushes and alleys where rapists can hide.

If you think you are being followed, walk quickly to areas where there are people and lights. If a car appears to be following you, turn and walk in the

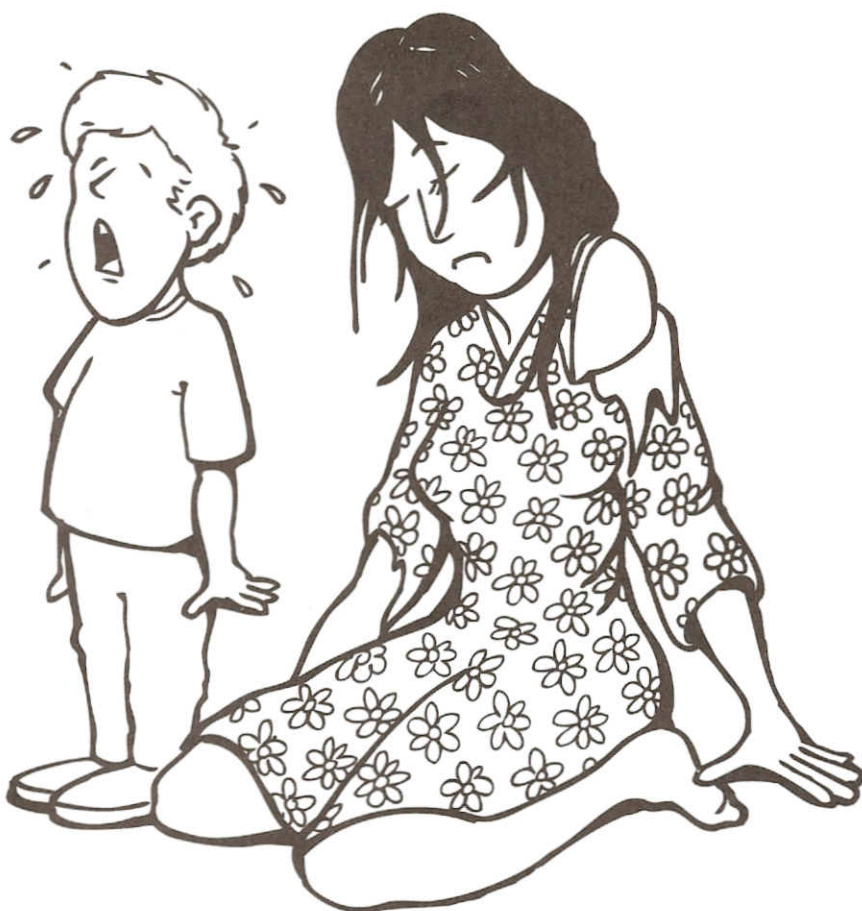

opposite direction or walk on the other side of the street.

Be careful when people stop you for directions, the time, or money. Always reply from a distance. Never get too close to a car. If you are in trouble or feel you are in danger. Don't be afraid to attract help any way you can. Scream, yell or run away to safety.

Always lock your car. Keep your car locked when you are away from it to keep someone from hiding and waiting inside. Look in side and around your car before you get in. When you are inside the car, lock the doors for safety. Be aware of other people in parking areas, especially those close to your vehicle.

### *What you should do if you are a victim:*

Seek help immediately! If you are injured, call 9-1-1 for medical assistance or go to a hospital emergency room. An important thing to remember is that you should not touch anything, change your clothes, wash, bathe, shower or douche until you have been to the hospital and contacted the police or sheriff. Doing any of these things will destroy valuable evidence that is needed by the police or sheriff and the prosecutor to identify, arrest and convict your attacker. The emotional impact of a sexual assault is great and both medical professionals and law enforcement officers know this. They know it will be difficult for you to confide in strangers about what has happened to you. Every effort is made to have family members, friends, clergy or anyone you want present to provide support during this difficult time.

### *What you should do if the victim is a child:*

Thousands of children suffer some type of sexual abuse each year. Who is the typical offender? In more than one-third of the sexual abuse cases involving children, the offender is known to the child and their family because the abuser is often a parent, relative or close family friend.

Because children are so trusting and defenseless, they are especially vulnerable to sexual assault. Children will often make up stories, but they rarely lie about being a victim of sexual assault. If a child tells you about being touched or assaulted, take it seriously. Your response helps determine how the child will react to the abuse. Stay calm. Explain that you are concerned about what happened, and definitely not angry with the child. Many children may feel as guilty, as if they provoked the assault. They need to be reassured they are not to blame, and that they are right to talk to you about what happened.

Sometimes a child may be too frightened or confused to talk directly about the abuse. Be alert for any changes in behavior that might hint that the child has suffered a disturbing experience.

# RURAL SECURITY

Rural crime is on the rise. Your sheriff or police can not possibly be in all places at all times. Your involvement in Neighborhood Watch is important because you and your neighbors must look out for each other. Many of the subjects covered elsewhere in this manual are, of course, useful in rural security. However, you have particular needs living and working in the country that are only covered here. If you live in a rural area:

- *Posting of warning signs is of special importance. Use street signs, window decals and place warning labels on out-buildings. For a list of these, see pages 30-31.*
- *Being involved with your local law enforcement agency, cooperative extension service or farm organization is extremely useful.*
- *Using of automatic timers for lights and radios, not only in the house but also in the barn and out buildings is a cheap preventative.*
- *Check into and use alarm systems for your house and other property. Have them hooked up to automatic dialers to call for help when you are away.*

## *Use the zone approach to providing security to reduce the risk of being a victim to theft or vandalism:*

### **Perimeter security zone:**

- Boundaries of the property serve as the first line of defense.
- Secure all entrances and access areas to your property. Barbed wire fences are a good deterrent to the casual criminal.

- Supplement fencing or limit access to open areas by creating deep drainage ditches and/or posts set in concrete.

- Dirt mounds might be useful and supplement or replace fencing as a less costly alternative.

Use the warning signs mentioned above, use on gates and locks, just make it undesirable to remove or vandalize your property.

### **Outlying security zone:**

- This is the most difficult area to secure and includes remote fields, pastures, timberlands and outlying buildings.

- Minimize exposure by following the instructions given below in "Three particular areas having special security needs."

### **Central work and storage area security zone:**

- Visibility and storage are the key factors in improving security in your central work area.
- Well-lit areas, marked properly, storing and locking up

implements, tools and supplies are vital.

- Your barns, storage bins, sheds and other buildings are built to keep out the weather, not the criminal.

- Strong doors, locks and windows are good insurance on these buildings - replace weak insecurity with strong security.

### *Three particular areas having special security needs are:*

#### **Livestock**

- Check your stock frequently and report missing stock immediately.
- Mark your animals with freeze or hot iron branding plus lip and ear tattooing - don't rely on easily removable ear tags.
- Check fences and gates regularly.
- Post signs discouraging rustlers.
- Lock chutes and corrals with sturdy chains and steel shackles and locks. File off the serial numbers on the padlocks.

#### **Farm Products**

- Keep farm products where they can be watched. This includes everything from seed to timber.
- Lock your gates and grain elevator.
- Mark grain with coded non-toxic confetti, easily removed by mills.
- Locate and keep a record (preferably photographs) of valuable trees. On your inven-

tory record the location, diameter, height and kind of trees on your property. Mark trees with a painted permanent stripe or identifying mark.

#### **Equipment and Supplies**

- Make sure your house, yard, corrals, and gas pumps are well lit.
- Timers on lights and radios can confuse burglars. Install them in out-buildings as well as the house.
- Gas pumps, tanks, storage bins and grain elevators should be locked with dead-bolt locks or padlocks.
- Your house and barn should be kept as secure as a city apartment. Provide them with adequate security.
- Keep boats, snowmobiles, bikes, fertilizers, tools and other small equipment locked up.
- Keep machinery where it can be seen from a neighbor's house or park it behind a hill or wooded area.
- Engrave your driver's license number and inventory on all equipment. See the Operation Identification section (pages 28-29) and pay particular attention to engraving your identification in an obvious and also in a non-obvious location.
- Secure power-driven implements with a case-hardened metal tow chain and a case-hardened padlock.
- Disable vehicles so they can't be driven away — remove the distributor cap, rotor and/or install hidden ignition kill switches.



# OPERATION IDENTIFICATION

# W

hat is

## Operation Identification?

Operation Identification is a nationwide program designed to discourage burglary and the theft of valuables from your home or business. The program provides a way for you and law enforcement officials to easily identify ownership of stolen property. **You permanently engrave your state and driver's license number (or, if you do not drive, an identification number which can be obtained from your state's Department of Motor Vehicles) on a permanent part of your property, not on an easily removed part.**

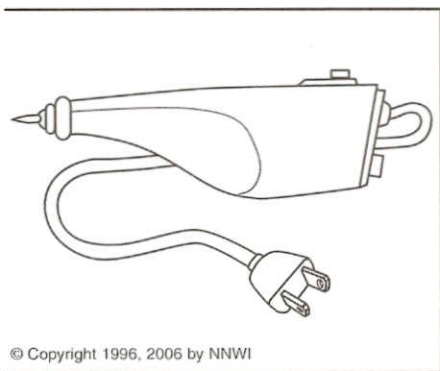

© Copyright 1996, 2006 by NNWI

## Why put the identification number on?

Property is stolen so it can be resold for cash. If you engrave your items the burglar will have difficulty selling them to his middleman or fence. He can't take them to a swap meet or pawn shop. As a stolen item its market value is low to start with, but engraving it with an ID number

makes it worth only 10% of even that. Marking property with an identifying number will discourage burglary and theft because thieves are far more likely to be convicted if caught with engraved property in their possession. If a burglar knows all the valuables in your home are marked, he is likely to look for an easier and more profitable victim. *Another good point to consider:*

When unmarked stolen property is taken into custody, it cannot be traced and returned to you.

## Where do you borrow or buy an engraver?

You can borrow an electric engraving pen from your local law enforcement agency. Better yet, you or one of your neighbors within your Neighborhood Watch group can purchase a very good engraver, with a diamond tip, for about \$20-\$25 capable of marking virtually any surface.

## How to use the engraver:

Hold the engraver straight up and down when in use. Adjust the tool for surface differences, if necessary. The higher the number or louder the noise the engraver makes indicates the hardness of the surface it will engrave. Put your two letter state abbreviation and your driver's license number on. (Not your social security number because that number is confidential and takes a good deal of time to trace.) If possible, engrave in two places, one obvious and one hidden.

## You do *not* want to engrave the following:

Jewelry, antiques, silver, artwork, heirlooms, stamps and coins need to be photographed or videotaped. When photographing

them, prop your driver's license up against them or along side of them so you can tie your ownership to these items in case of theft or burglary.

## If you move out of your state and your driver's license number is no longer valid:

All states motor vehicle registration departments will cooperate with law enforcement giving them your forwarding address *if you advise the department of your new address*. If you have permanently marked your possessions, it is highly advisable to do that.

## After I engrave my possessions, what then?

The **National Neighborhood Watch Institute** provides a "NNWI Inventory of Household Items Engraved with Driver's License Number" forms for your use. Both sides of the form are illustrated on the preceding page. Places for listing the articles, the manufacturer and the serial number, the location you engraved, and the purchase price is included. On the reverse of the form is an extended list of items that are frequently stolen so you can use it as a check list of your own property, and a section to list your credit cards, their account numbers and phone numbers to call in the event your cards are lost or stolen. Put this completed form, together with your photographs and videotapes, in a safe place with your written records such as copies of your tax returns, your insurance policies and other legal documents. You should also place a decal in your window letting any potential burglar know that you are involved in Neighborhood Watch. You may also want to place an Operation ID decal in your window.

# NEIGHBORHOOD WATCH MATERIALS

## **N**eighborhood Watch Decals & Labels

All the decals and labels are red and black (Masked Bad Guy and Boris the Burglar<sup>sm</sup>) or blue and black (Crime Watch Blue Eye). Decals are for placing on the inside of windows. Labels are for placing on top of surfaces. All are available in Mini-Packages of 12.

- **3" x 3" Window Warning Decals Neighborhood Scene**

Law Enforcement Agency Type  
*Reverse reading, suitable for placing on the inside of windows so it can be read from the opposite side. Vinyl surface. More sun-resistant than the labels. These are made 4 decals on a 12" x 3" sheet with slits between them. Packaged in 50 sheets of 4 for 200 total. Blue Eye also available as labels.*

- **3½" x 3½" Static Kling Window Warning Decals Neighborhood Scene**

Law Enforcement Agency type.  
*Reverse reading, suitable for placing on the inside of windows so it can be read from the opposite side. Vinyl surface. More sun-resistant than the labels. These are made 3 decals on a 10½" x 3½" sheet with slits between them. Packaged in 50 sheets of 3 for 150 total.*

- **3" x 4" Window Warning Decals "We Look Out For Each Other!" Warning**

both Police and Sheriff Agency types.  
*Reverse reading, suitable for placing on the inside of windows so it can be read from the opposite side. Vinyl surface. More sun-resistant than the labels. These are made 3 decals on a 9" x 4" sheet with slits between them. Packaged in 50 sheets of 3 for 150 total. Also available as labels.*

- **4-1/2" x 6" Window Warning Decals "We Look Out For Each Other!" Warning**

Both Police and Sheriff Agency types.  
*Reverse reading, suitable for placing on the inside of windows so it can be read from the opposite side. Vinyl surface. More sun-resistant than the labels. These are packaged in 100s.*

- **5" x 5" Window Warning Decals Neighborhood Scene**

Law Enforcement Agency type.  
*Reverse reading, suitable for placing on the inside of windows so it can be read from the opposite side. Vinyl surface. More sun-resistant than the labels. These are made 4 decals on a 12" x 3" sheet with slits between them. Packaged in 100s. Also available as labels.*

- **5-1/2" x 4-7/8" Window Warning Decals**

The same used since 1982. Both Police and Sheriff Agency types.  
*Reverse reading, suitable for placing on the inside of windows so it can be read from the opposite side. Vinyl surface. More sun-resistant than the labels. Packed in 100s.*

## **N**eighborhood Watch Street Signs

All the signs are red and black (Masked Bad Guy and Boris the Burglar<sup>sm</sup>) or blue and black (Crime Watch Blue Eye) in both Sheriff and Police Versions or Law Enforcement Version with the Neighborhood Scene. They are silk-screened on to a white surface. The all-aluminum signs have baked white enamel on **both** sides and have a fade-resistant coating. Plastic signs are all white also. These will NOT rust. Our 18" x 24" & 12" x 18" signs are also available with 3M<sup>®</sup> Reflective coating. All signs are round-cornered and punched with two holes for easy mounting.

The "Warning" message is white with black borders against the red background on the standard signs. Easy to read in low-light conditions. The standard signs have the easy to understand message: "We Look Out For Each Other!"

The Neighborhood Scene presents a "softer" image of the presence of a Neighborhood Watch group in the community. It is available only in the Law Enforcement Agency type. Both the standard and the Neighborhood Scene styles (aluminum signs) can be customized with your local agency name and phone number.

- **18" x 24" Large Aluminum or Reflective Street Warning Signs**

Made of .063" aluminum  
*Available in single signs. Traditional (Police or Sheriff Agency Types) or Neighborhood Scene (Law Enforcement Agency type). Signs can be customize at additional cost.*

- **12" x 18" Medium Aluminum or Reflective Street Warning Signs**

Made of .050" aluminum  
*Available in single signs. Traditional (Police or Sheriff Agency Types) or Neighborhood Scene (Law Enforcement Agency type). Signs can be customize at additional cost.*

- **12" x 12" Square Aluminum Street Warning Signs**

Made of .050" aluminum  
*Available in single signs. Neighborhood Scene (Law Enforcement Agency type) only. Signs can be customize at additional cost.*

- **9" x 12" Small Aluminum Street Warning Signs**

Made of .050" aluminum  
*Available in single signs. Traditional (Police or Sheriff Agency Types) or Neighborhood Scene (Law Enforcement Agency type). Signs can be customize at additional cost.*

- **12" x 12" Square Plastic Street Warning Signs**

Made of .035" thick plastic  
*Available in single signs. Neighborhood Scene (Law Enforcement Agency type) only. Not available with customized imprint.*

- **9" x 12" Small Plastic Street Warning Signs**

Made of .035" thick plastic  
*Available in single signs. Traditional (Police or Sheriff Agency Types) or Neighborhood Scene (Law Enforcement Agency type). Not available with customized imprint.*

- **5" x 5" Square Plastic Street Warning Signs**

Made of .035" thick plastic  
*Available in single signs. Neighborhood Scene (Law Enforcement Agency type) only. Not available with customized imprint.*

# Worksheets

■ **Family Data Sheet** - A letter size form designed to be completed, copied and given to each Neighbor-Participant in the program. Information includes the family name, address, names of all the occupants, their ages, their work schedules, their vehicles, skills they are willing to share with the group, contact to be called in case of an emergency and other bits of information. Information about kids, seniors and pets is also solicited. To prevent burglaries, the routine help and their schedules in and around the home and whether an alarm system is in place is also asked for. This Family Data Sheet, in the hands of your neighbors, is great insurance for achieving a crime-proof neighborhood. **"We Look Out For Each Other!"** can best be accomplished by every Neighbor-Participant knowing this information about a family. Because of the confidential nature of much of this information, its distributions is very limited and those receiving it are expected to study it then keep it put away in a safe place. *This is the most important tool in the Neighborhood Watch crime prevention program.*

■ **Family Data Summary Sheet** - This is a brief condensation of ten Family Data Sheets so it can be kept near at hand for quick reference. It provides for listing of the address, occupants, their phones, work schedules, vehicle identification, routine help schedules and the names/phones of the kid's doctor and emergency contacts. It can be easily copied, being a single letter sized card, and made available to each mature family member.

- **Block Maps** - Generic layouts of the houses on a block which allows for entering the address, family names, home and work phone numbers of the principal occupants. Printed two sides on a letter size sheet, two common layout maps are provided. If your neighborhood, mobile home park or apartment building does not fit this format, it will at least give you a format to allow you to create your own block map.
- **Telephone Tree** - a letter size card setting out the path for telephone messages to be passed through the organization. No one person need call more than three other people and in a matter of less than 2 minutes all 19 people in the group should be able to be contacted. Great for passing along information about a possible intruder in the neighborhood, about a call to 9-1-1, or simply to get information passed along to the group.
- **Household Inventory Sheets** - a letter sized card, printed on both sides. The front side is for listing the article, manufacturer and model, serial number, location marked and purchase price. The reverse side has a list of items that are frequently stolen which you can use as a reminder as you do your own inventory. There is also a place for listing your credit card numbers and the phone numbers you need to call in the event any of the cards are lost or stolen.

## Starter Kits

- **Starter Kit** contains: 2 - 9" x 12" signs (1 aluminum, 1 plastic), 15 decals, 3 copies of all 3 handbooks and 3 copies each of all 5 work sheets. Available in Masked Bad Guy, Boris the Burglarsm or Blue Eye styles in both Police and Sheriff Agency types. Starter Kits with the Neighborhood Scene have a slightly different composition. See catalog for details.

## Operation Identification System

NNWI now offers a proven system for property protection. This system includes decals for windows, labels for outside surfaces and Inventory Worksheets. These tools provide a deterrent to a thief by making your valuables easily traceable. If your valuables are ever stolen, your law enforcement agency should be able to identify them and get them back to you quickly.

- **3" x 3" and 3-1/2" x 5" Window Warning Decals** for Inside of Windows *Reverse reading, suitable for placing on the inside of windows so they can be read from the opposite side. Vinyl surface. 3" x 3" are packaged in 100s, 3-1/2" x 5" are packaged in 50s. Available in Masked Bad Guy and Blue Eye Versions.*
- **3" x 3" and 3-1/2" x 5" Window Warning Labels** for placing on Top of Surfaces *Suitable for placing on the top of surfaces so they can be easily read. Vinyl surface. 3" x 3" are packaged in 100s, 3-1/2" x 5" are packaged in 50s. Available in Masked Bad Guy and Blue Eye Versions.*

**Start your Operation Identification program today.**

## To Order

Fax your order 24-hours a day to **(888) 329-6694** or call the National Neighborhood Watch Institute 8:00 AM to 5:00 PM PT at **(888) 669-4872**

Order On-Line via the web at **[www.nnwi.org](http://www.nnwi.org)**

# Handbooks

- **Participants' Handbook** - 32 pp, two color, approx. 8-1/2" x 11" (letter) size. A comprehensive guide to the benefits of joining Neighborhood Watch, how the program works, getting involved with your neighbors for mutual aid, direction and location training, instruction on observations and recognition, suspicious activities and sounds, suspect and vehicle identification, how to report a crime, etc.  
*A must for every Participant!*

- **Home and Personal Security Handbook** - 32 pp, two color, approx. 8-1/2" x 11" (letter) size. An excellent guide covering home security and safety, with check-lists and illustrations of the many types of doors, windows and locks. Operation Identification, tips on the prevention of car-jacking, what to avoid and do in event of a sexual assault, preventing ATM hold-ups, special emphasis on apartment and rural security, vacation preparations and kids home alone. Crime prevention begins with self-protection.  
*This is an excellent "How to..." guide.*

- **How to Start (and Maintain a Healthy) Neighborhood Watch Program** - 16 pp, two color, approx. 8-1/2" x 11" (letter) size. A guide book giving you a week by week program to start your program, what you do at the first meeting and then at subsequent meetings. A typical meeting agenda and suggested meeting topics. 22 ideas of other things a Neighborhood Watch group can do, benefits of the program, a sample flyer to kick off your meetings and samples of the paper work which make the program flow easy.  
*Want to start a program? Here's how.*

## HERE ARE 20 QUESTIONS

If you can answer them all quickly and correctly, keeping you and your family's personal safety and security as your main concern, you are well on your way to being safe and secure.

If you have any hesitation, open this handbook again and review it.

- 1 What are the three D's of Protection?
- 2 What are they meant to protect you from?
- 3 Should you always have your car keys in your hand when you approach your car?
- 4 What should you do before getting in to your car?
- 5 How do you carry your purse in a crowd?
- 6 Do you ever hide a house key to let a repairman do work while you are away?
- 7 Is your front door lock the best available?
- 8 What should you do with that serial number on the new padlock?
- 9 What do you do if someone demands your car keys?
- 10 How do you secure a sliding glass patio door?
- 11 Is your open garage door an open invitation to a thief?
- 12 Do you lend your ATM card to anyone?
- 13 Do you have your home address and phone number on your key-ring and luggage tags?
- 14 Where do you stand in an elevator?
- 15 Have you listed your credit card numbers somewhere?
- 16 Do you always remove your keys and lock you car as you leave it?
- 17 Did you check your smoke detector battery within the past six months?
- 18 Since you moved in, have you changed locks?
- 19 Have you etched your drivers license number on your TVs?
- 20 What is your local law enforcement agency's emergency phone number?